

RS485 MODBUS Module 16O

Expansion Module – 16 digital outputs

Version 1.0 — 02/01/2014

User Manual



SFAR
Solutions For Automation & Robotics

Manufactured for

aspar

CE

Thank you for choosing our product.

This manual will help you with proper support and proper operation of the device.

The information contained in this manual have been prepared with utmost care by our professionals and serve as a description of the product without incurring any liability for the purposes of commercial law.

This information does not release you from the obligation of own judgment and verification.

We reserve the right to change product specifications without notice.

Please read the instructions carefully and follow the recommendations contained therein.



WARNING!

Failure to follow instructions can result in equipment damage or impede the use of the hardware or software.

1. Safety rules

- Before first use, refer to this manual
- Before first use, make sure that all cables are connected properly
- Please ensure proper working conditions, according to the device specifications (eg: supply voltage, temperature, maximum power consumption)
- Before making any modifications to wiring connections, turn off the power supply

2. Module Features

2.1. Purpose and description of the module

16O Module is an innovative device that provides a simple and cost-effective extension of the number of outputs in popular PLCs.

The module has 16 digital outputs. All inputs and outputs are isolated from the logic of using optocouplers.

The module is produced in two versions with PNP and NPN outputs:

Mark	Output type
16O-PNP	PNP
16O-NPN	NPN

This module is connected to the RS485 bus with twisted-pair wire. Communication is via MODBUS RTU or MODBUS ASCII. The use of 32-bit ARM core processor provides fast processing and quick communication. The baud rate is configurable from 2400 to 115200.

The module is designed for mounting on a DIN rail in accordance with DIN EN 5002.

The module is equipped with a set of LEDs used to indicate the status of outputs useful for diagnostic purposes and helping to find errors.

Module configuration is done via USB by using a dedicated computer program. You can also change the parameters using the MODBUS protocol.

2.2. Technical Specifications

Power Supply	Voltage	12-24 V DC \pm 20%
	Maximum Current*	180 mA @ 12V / 100 mA @ 24V
Digital Outputs	No of outputs	16
	Max Voltage	30V
	Max current	500mA
	Output Type	PNP or NPN (depends on version)
Temperature	Work	-10 °C - +50°C
	Storage	-40 °C - +85°C
Connectors	Power Supply	2 pin
	Communication	3 pin
	Outputs	10 pin
	Quick connector	IDC10
	Configuration	Mini USB
Size	Height	120 mm
	Length	101 mm
	Width	22,5 mm
Interface	RS485	Up to 128 devices

* Maximum current with active Modbus transmission, all outputs on and high state on all inputs

2.3. Dimensions of the product

Look and dimensions of the module are shown below. The module is mounted directly to the rail in the DIN industry standard. Power connectors, communication and IOs are at the bottom and top of the module. USB connector configuration and indicators located on the front of the module.

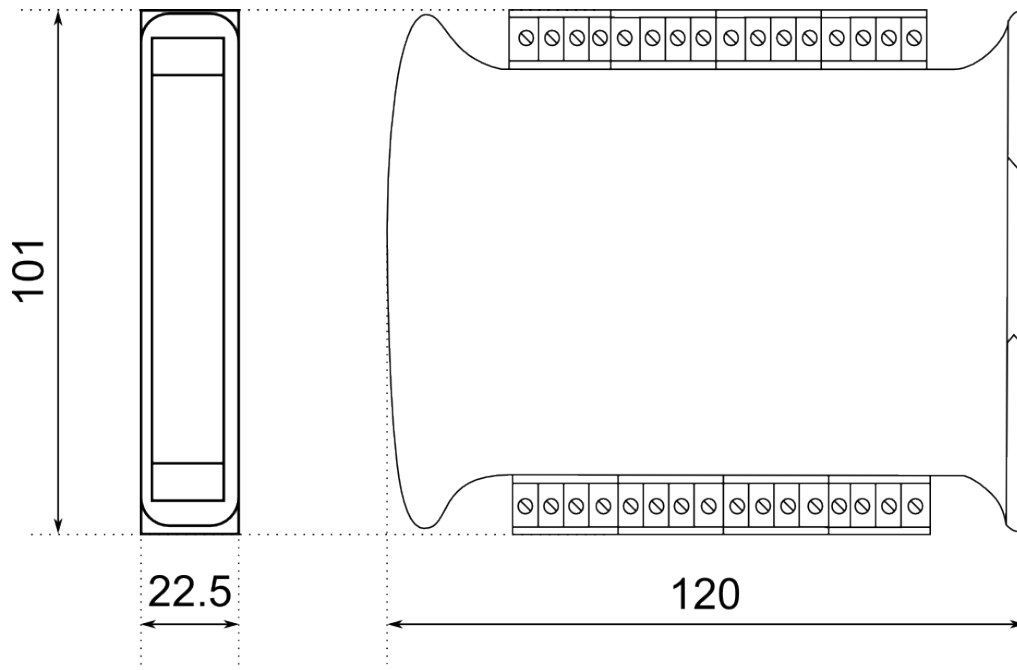

3. Communication configuration

3.1. Grounding and shielding

In most cases, IO modules will be installed in an enclosure along with other devices which generate electromagnetic radiation. Examples of these devices are relays and contactors, transformers, motor controllers etc. This electromagnetic radiation can induce electrical noise into both power and signal lines, as well as direct radiation into the module causing negative effects on the system. Appropriate grounding, shielding and other protective steps should be taken at the installation stage to prevent these effects. These protective steps include control cabinet grounding, module grounding, cable shield grounding, protective elements for electromagnetic switching devices, correct wiring as well as consideration of cable types and their cross sections.

3.2. Network Termination

Transmission line effects often present a problem on data communication networks. These problems include reflections and signal attenuation.

To eliminate the presence of reflections from the end of the cable, the cable must be terminated at both ends with a resistor across the line equal to its characteristic impedance. Both ends must be terminated since the direction of propagation is bi-directional. In the case of an RS485 twisted pair cable this termination is typically 120 Ω .

3.3. Setting Module Address in RS485 Modbus Network

The following table shows how to set switch to determine the address of the module. The module address is set with the switches in the range of 0 to 31. Addresses From 32 to 255 can be set via RS485 or USB.

Adr	SW5	SW4	SW3	SW2	SW1	Adr	SW5	SW4	SW3	SW2	SW1	Adr	SW5	SW4	SW3	SW2	SW1
0	OFF	OFF	OFF	OFF	OFF	11	OFF	ON	OFF	ON	ON	22	ON	OFF	ON	ON	OFF
1	OFF	OFF	OFF	OFF	ON	12	OFF	ON	ON	OFF	OFF	23	ON	OFF	ON	ON	ON
2	OFF	OFF	OFF	ON	OFF	13	OFF	ON	ON	OFF	ON	24	ON	ON	OFF	OFF	OFF
3	OFF	OFF	OFF	ON	ON	14	OFF	ON	ON	ON	OFF	25	ON	ON	OFF	OFF	ON
4	OFF	OFF	ON	OFF	OFF	15	OFF	ON	ON	ON	ON	26	ON	ON	OFF	ON	OFF
5	OFF	OFF	ON	OFF	ON	16	ON	OFF	OFF	OFF	OFF	27	ON	ON	OFF	ON	ON
6	OFF	OFF	ON	ON	OFF	17	ON	OFF	OFF	OFF	ON	28	ON	ON	ON	OFF	OFF
7	OFF	OFF	ON	ON	ON	18	ON	OFF	OFF	ON	OFF	29	ON	ON	ON	OFF	ON
8	OFF	ON	OFF	OFF	OFF	19	ON	OFF	OFF	ON	ON	30	ON	ON	ON	ON	OFF
9	OFF	ON	OFF	OFF	ON	20	ON	OFF	ON	OFF	OFF	31	ON	ON	ON	ON	ON
10	OFF	ON	OFF	ON	OFF	21	ON	OFF	ON	OFF	ON						

3.4. Types of Modbus Registers

There are 4 types of variables available in the module

Type	Beginning address	Variable	Access	Modbus Command
1	00001	Digital Outputs	Bit Read & Write	1, 5, 15
2	10001	Digital Inputs	Bit Read	2
3	30001	Input Registers	Registered Read	3
4	40001	Output Registers	Registered Read & Write	4, 6, 16

3.5. Communication settings

The data stored in the modules memory are in 16-bit registers. Access to registers is via MODBUS RTU or MODBUS ASCII.

3.5.1. Default settings

You can restore the default configuration by the switch SW6 (see 3.5.2 - Restore the default configuration)

Baud rate	19200
Parity	No
Data bits	8
Stop bits	1
Reply Delay [ms]	0
Modbus Type	RTU

3.5.2. Restore the default configuration

To restore the default configuration:

- turn off the power
- turn on the switch SW6
- turn on the power
- when power and communication LED flash turn off the switch SW6

Caution! After restoring the default configuration all values stored in the registers will be cleared as well.

3.5.3. Configuration registers

Modbus	Dec	Hex	Name	Values
Address				
40003	2	0x02	Baud rate	0 – 2400 1 – 4800 2 – 9600 3 – 19200 4 – 38400 5 – 57600 6 – 115200 other – value * 10
40005	4	0x04	Parity	0 – none 1 – odd 2 – even 3 – always 1 4 – always 0
40004	3	0x03	Stop Bits LSB	1 – one stop bit 2 – two stop bits
40004	3	0x03	Data Bits MSB	7 – 7 data bits 8 – 8 data bits
40006	5	0x05	Response delay	Time in ms
40007	6	0x06	Modbus Mode	0 – RTU 1 – ASCII

4. Indicators

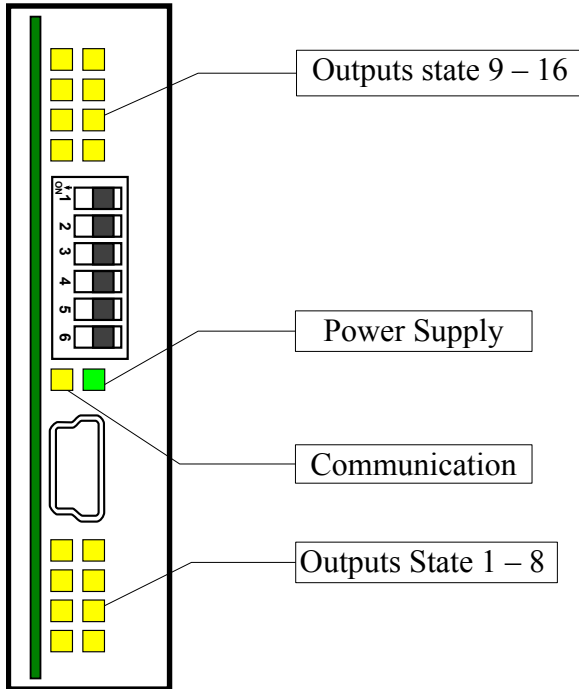

Indicator	Description
Power supply	LED indicates that the module is correctly powered.
Communication	The LED lights up when the unit received the correct packet and sends the answer.
Outputs state	LED indicates that the output is on.

5. Module Connection – PNP outputs

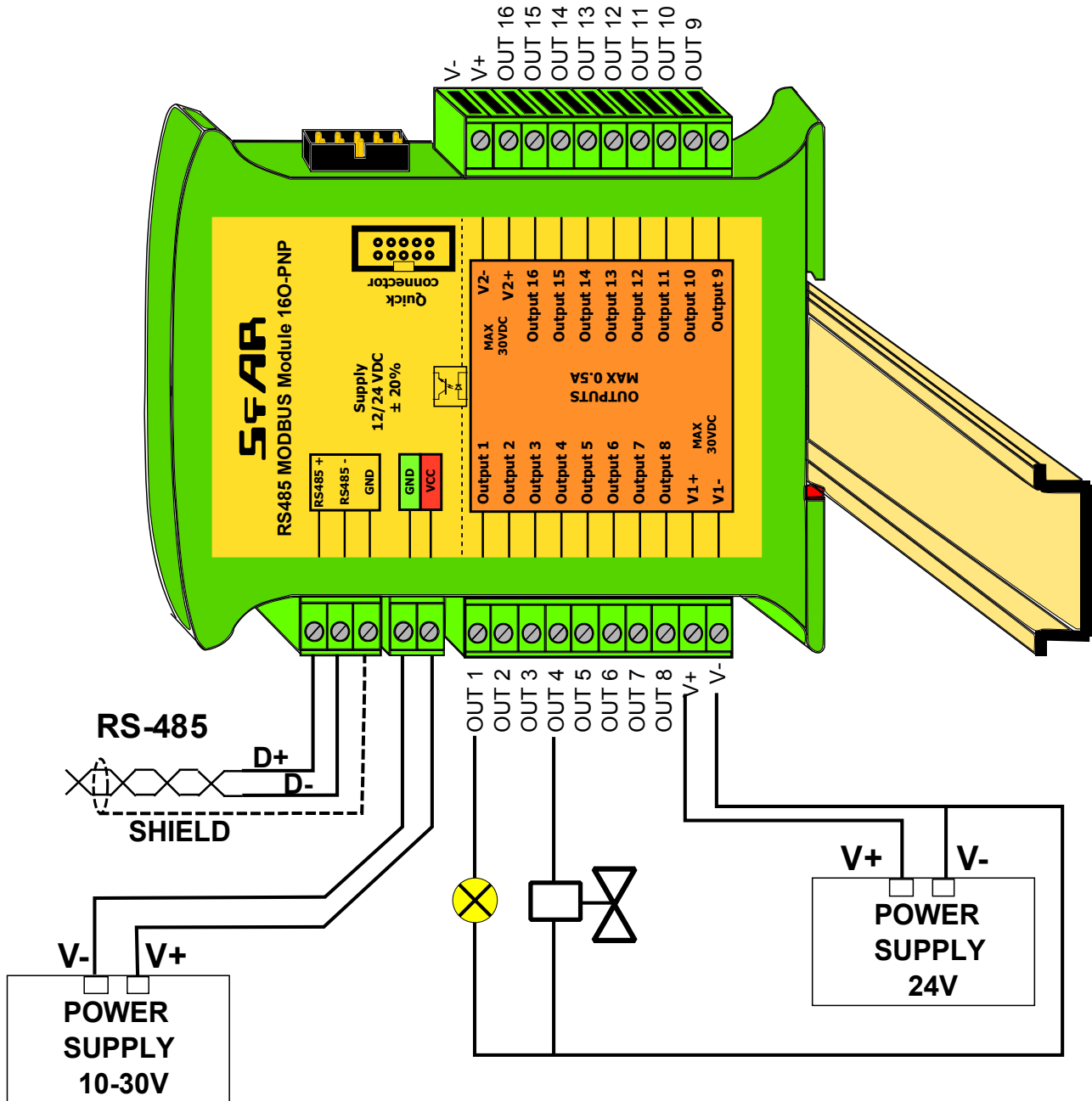

6. Module Connection – NPN outputs

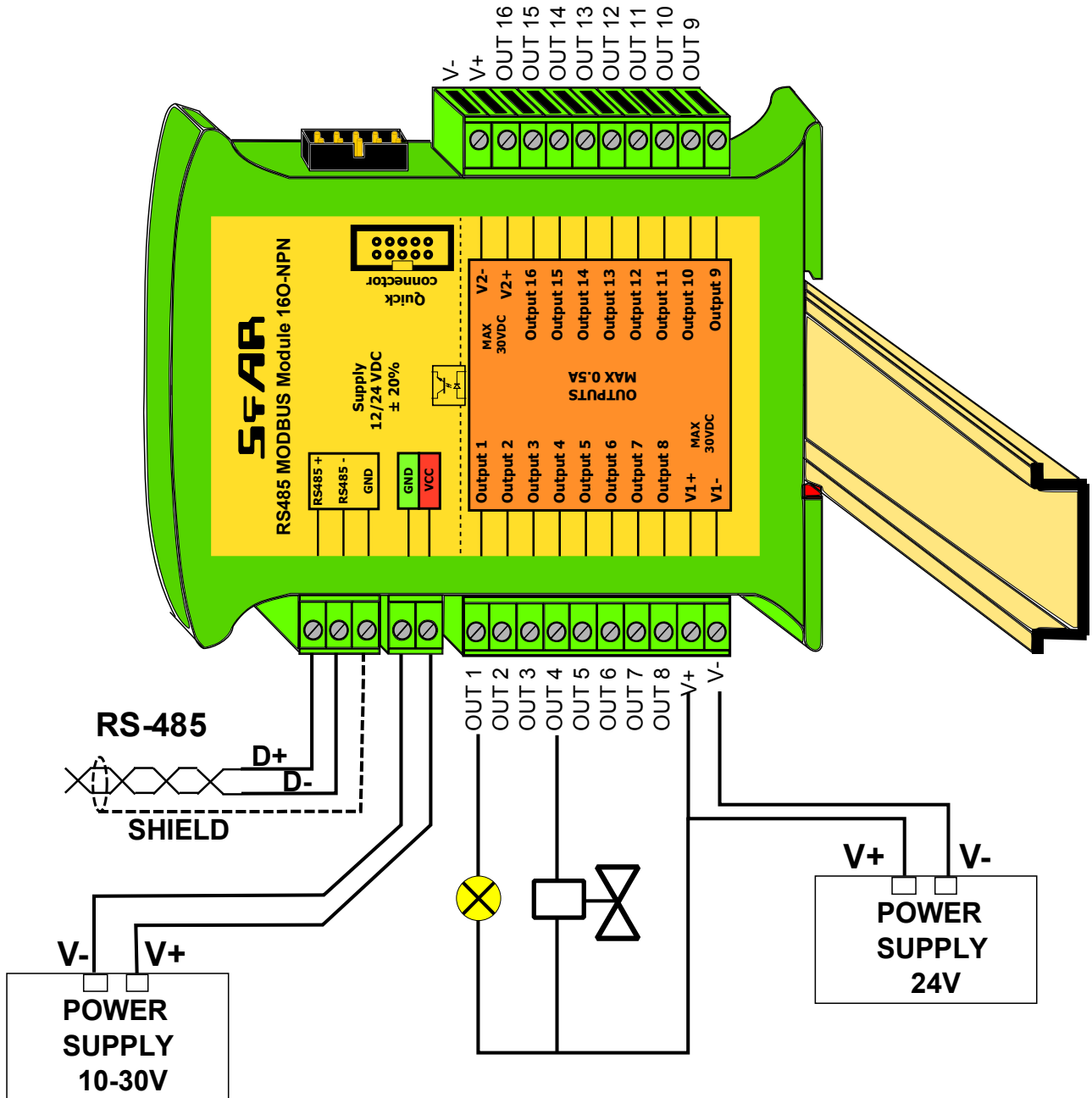

7. Switches

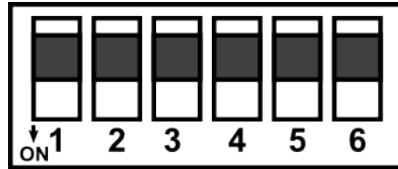

Switch	Function	Description
1	Module address +1	Setting module address from 0 to 31
2	Module address +2	
3	Module address +4	
4	Module address +8	
5	Module address +16	
6	Restoring default settings	Restoring default settings (see 3.5.1 - Default settings and 3.5.2 - Restore the default configuration).

8. Modules Registers

8.1. Registered access

Modbus	Dec	Hex	Register Name	Access	Description
30001	0	0x00	Version/Type	Read	Version and Type of the device
30002	1	0x01	Switches	Read	Switches state
40003	2	0x02	Baud rate	Read & Write	RS485 baud rate
40004	3	0x03	Stop Bits & Data Bits	Read & Write	No of Stop bits & Data Bits (see 3.5.3)
40005	4	0x04	Parity	Read & Write	Parity bit
40006	5	0x05	Response Delay	Read & Write	Response delay in ms
40007	6	0x06	Modbus Mode	Read & Write	Modbus Mode (ASCII or RTU)
40009	8	0x08	Watchdog	Read & Write	Watchdog
40013	12	0x0C	Default Output State	Read & Write	Default output state (after power on or watchdog reset)
40033	32	0x20	Received packets MSB	Read & Write	No of received packets
40034	33	0x21	Received packets LSB	Read & Write	
40035	34	0x22	Incorrect packets MSB	Read & Write	No of received packets with error
40036	35	0x23	Incorrect packets LSB	Read & Write	
40037	36	0x24	Sent packets MSB	Read & Write	No of sent packets
40038	37	0x25	Sent packets LSB	Read & Write	
40052	51	0x33	Outputs	Read & Write	Output state

8.2. Bit access

Modbus Address	Dec Address	Hex Address	Register name	Access	Description
193	192	0x0C0	Default state of output 1	Read & Write	Default state of output 1
194	193	0x0C1	Default state of output 2	Read & Write	Default state of output 2
195	194	0x0C2	Default state of output 3	Read & Write	Default state of output 3
196	195	0x0C3	Default state of output 4	Read & Write	Default state of output 4
197	196	0x0C4	Default state of output 5	Read & Write	Default state of output 5
198	197	0x0C5	Default state of output 6	Read & Write	Default state of output 6
199	198	0x0C6	Default state of output 7	Read & Write	Default state of output 7
200	199	0x0C7	Default state of output 8	Read & Write	Default state of output 8
201	200	0x0C8	Default state of output 9	Read & Write	Default state of output 9
202	201	0x0C9	Default state of output 10	Read & Write	Default state of output 10
203	202	0x0CA	Default state of output 11	Read & Write	Default state of output 11
204	203	0x0CB	Default state of output 12	Read & Write	Default state of output 12
205	204	0x0CC	Default state of output 13	Read & Write	Default state of output 13
206	205	0x0CD	Default state of output 14	Read & Write	Default state of output 14
207	206	0x0CE	Default state of output 15	Read & Write	Default state of output 15
208	207	0x0CF	Default state of output 16	Read & Write	Default state of output 16
817	816	0x330	Output 1	Read & Write	Output 1 state
818	817	0x331	Output 2	Read & Write	Output 2 state
819	818	0x332	Output 3	Read & Write	Output 3 state
820	819	0x333	Output 4	Read & Write	Output 4 state
821	820	0x334	Output 5	Read & Write	Output 5 state
822	821	0x335	Output 6	Read & Write	Output 6 state
823	822	0x336	Output 7	Read & Write	Output 7 state
824	823	0x337	Output 8	Read & Write	Output 8 state
825	824	0x338	Output 9	Read & Write	Output 9 state
826	825	0x339	Output 10	Read & Write	Output 10 state
827	826	0x33A	Output 11	Read & Write	Output 11 state
828	827	0x33B	Output 12	Read & Write	Output 12 state
829	828	0x33C	Output 13	Read & Write	Output 13 state
830	829	0x33D	Output 14	Read & Write	Output 14 state
831	830	0x33E	Output 15	Read & Write	Output 15 state
832	831	0x33F	Output 16	Read & Write	Output 16 state

9. Configuration software

Modbus Configurator is software that is designed to set the module registers responsible for communication over Modbus network as well as to read and write the current value of other registers of the module. This program can be a convenient way to test the system as well as to observe real-time changes in the registers.

Communication with the module is done via the USB cable. The module does not require any drivers.

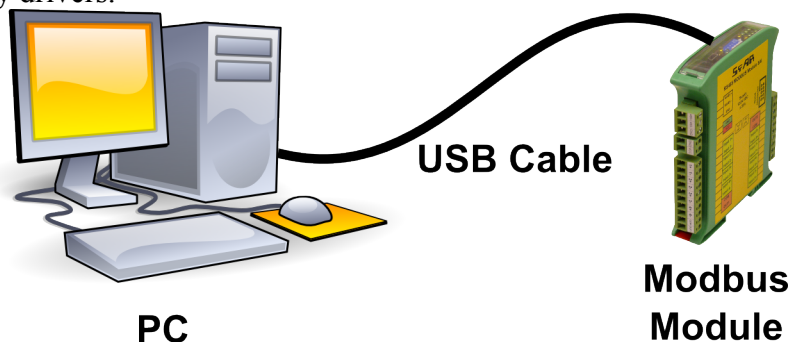

Configurator is a universal program, whereby it is possible to configure all available modules.

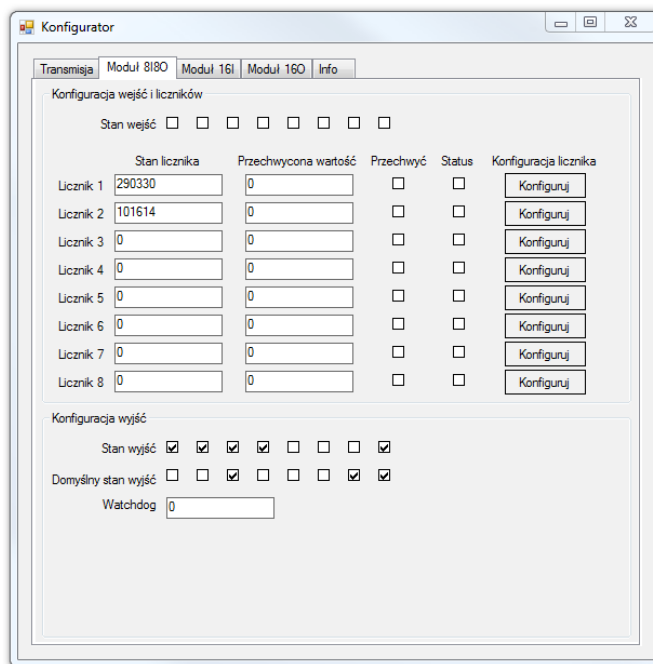

Table of content

1. Safety rules.....	3
2. Module Features.....	3
2.1. Purpose and description of the module.....	3
2.2. Technical Specifications.....	4
2.3. Dimensions of the product.....	5
3. Communication configuration.....	6
3.1. Grounding and shielding.....	6
3.2. Network Termination.....	6
3.3. Setting Module Address in RS485 Modbus Network.....	6
3.4. Types of Modbus Registers.....	7
3.5. Communication settings.....	7
3.5.1. Default settings.....	7
3.5.2. Restore the default configuration.....	7
3.5.3. Configuration registers.....	8
4. Indicators.....	9
5. Module Connection – PNP outputs.....	10
6. Module Connection – NPN outputs.....	11
7. Switches.....	12
8. Modules Registers.....	13
8.1. Registered access.....	13
8.2. Bit access.....	14
9. Configuration software.....	15



Manufactured for:
Aspar s.c.
 ul. Kapitańska 9
 81-331 Gdynia
 Poland

ampero@ampero.eu
www.ampero.eu

Tel. +48 58 351 39 89; +48 58 732 71 73

